

LEGENDA/NOTE:

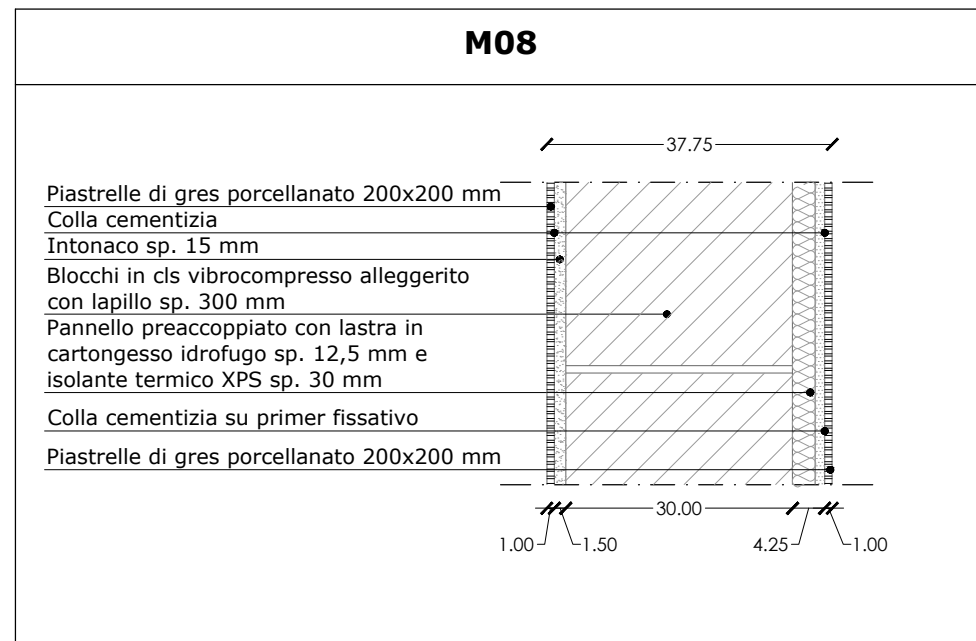
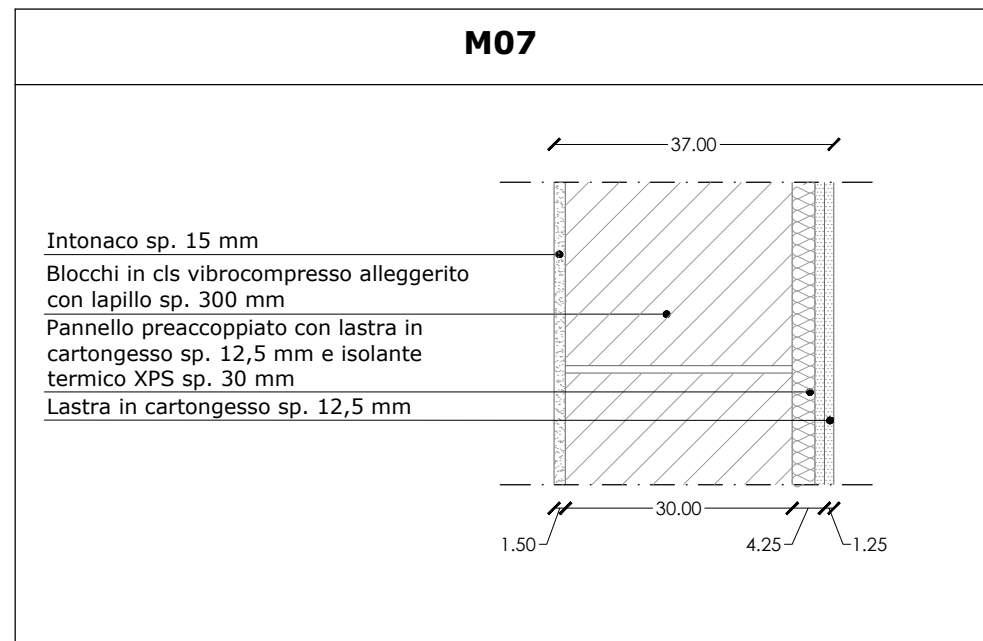
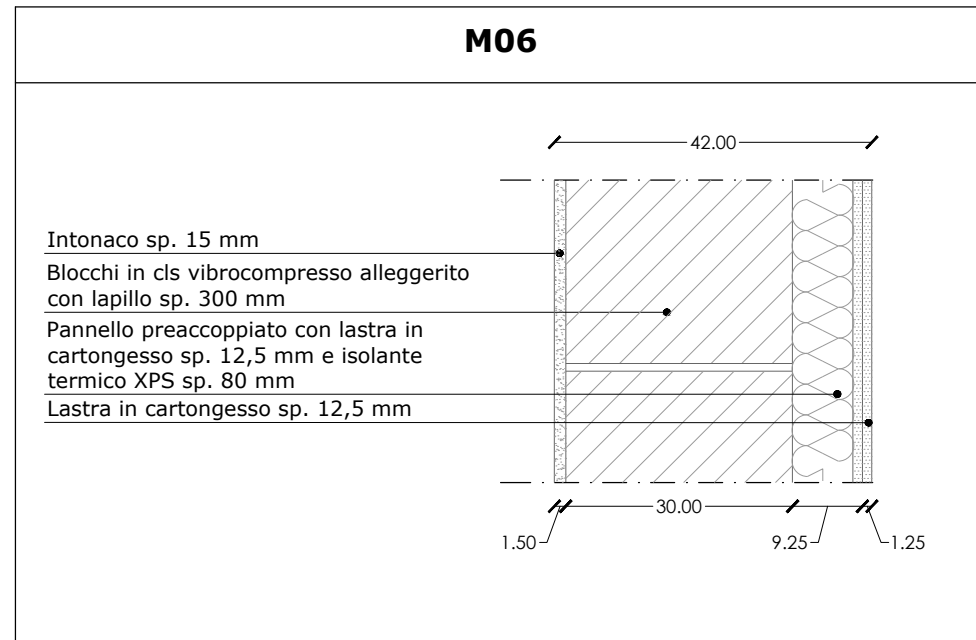
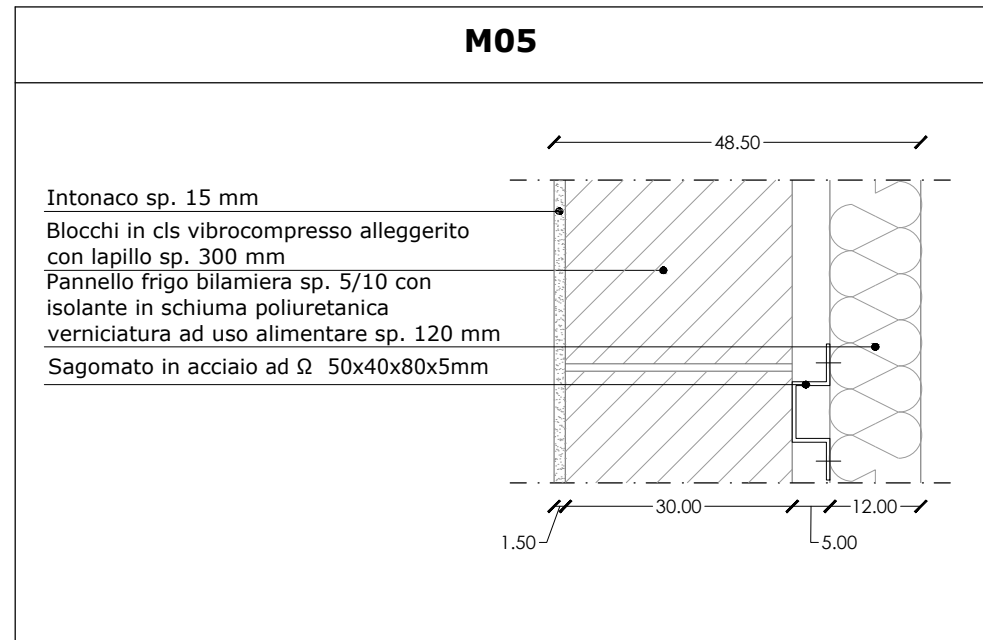

Abaco delle murature - Rapp. 1:10

01
Ar-P-Es-19

REV.	DATA	DESCRIZIONE
01	25/10/2017	Emissione